

形競技 幼児男子

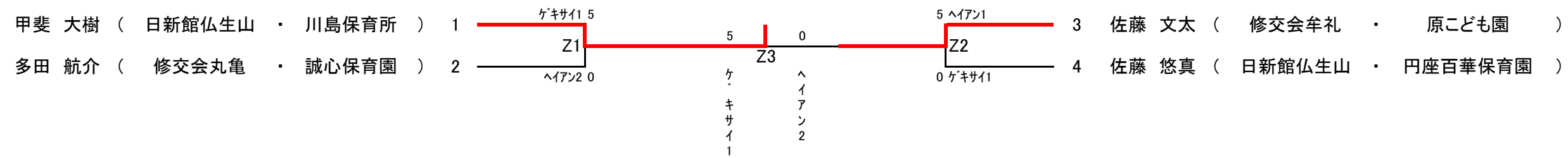

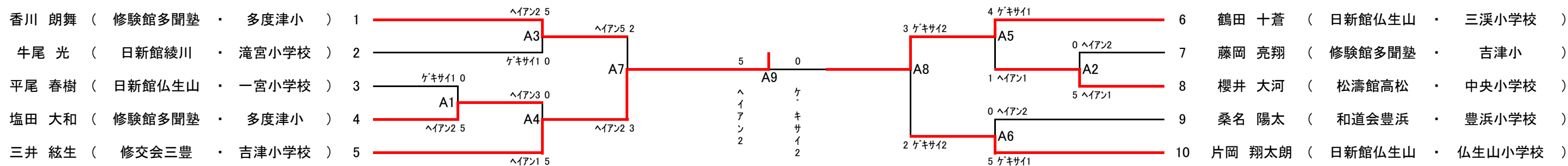

形競技 小学1年女子

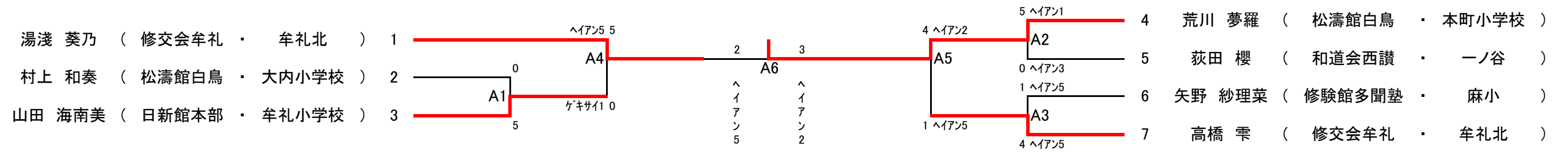

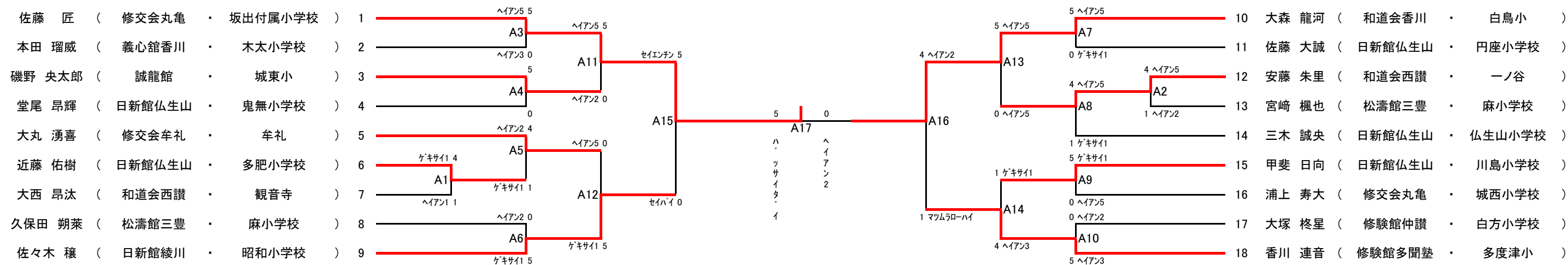

形競技 小学2年女子

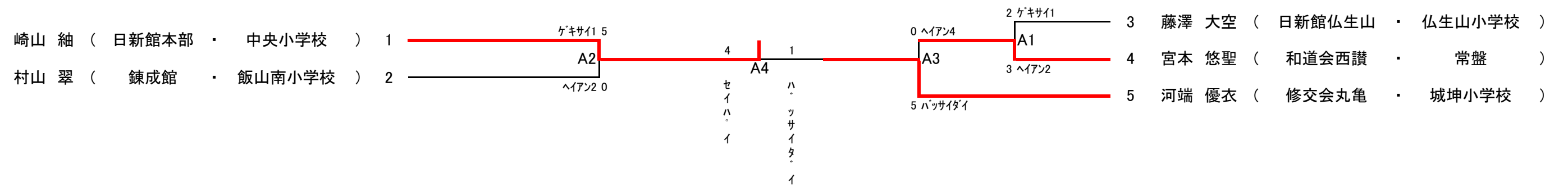

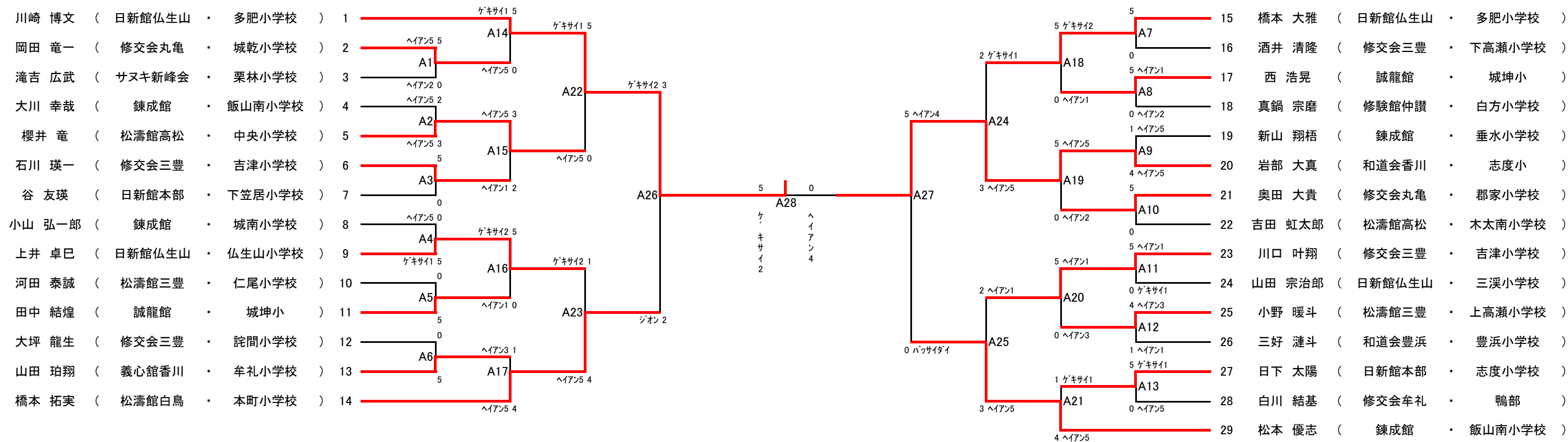

形競技 小学3年女子

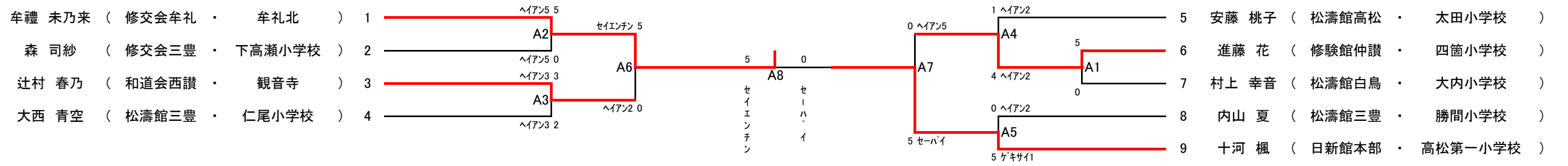

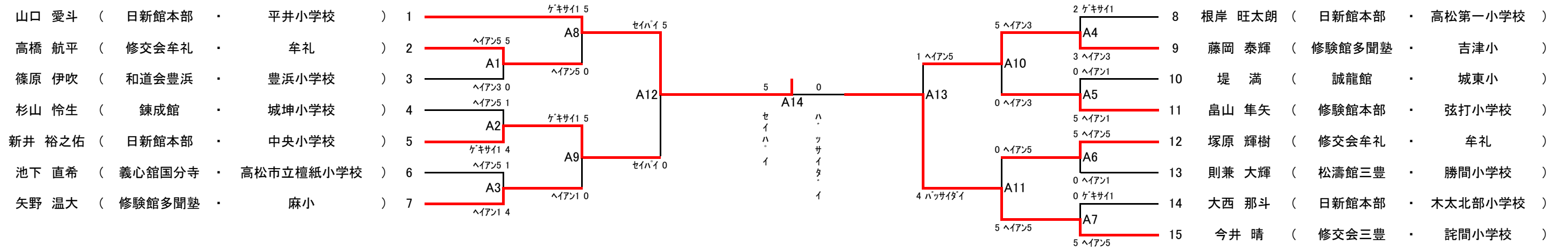

形競技 小学4年女子

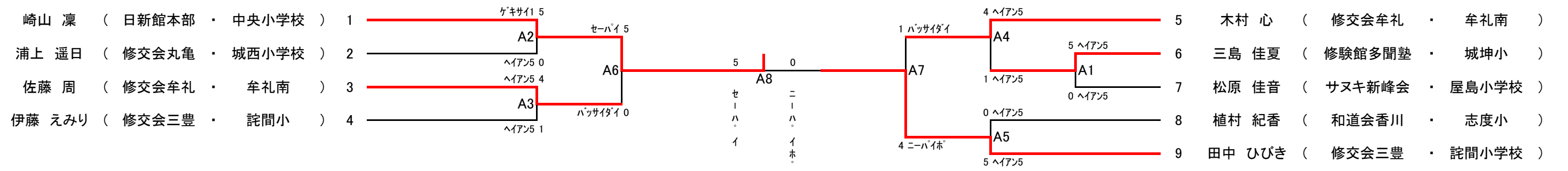

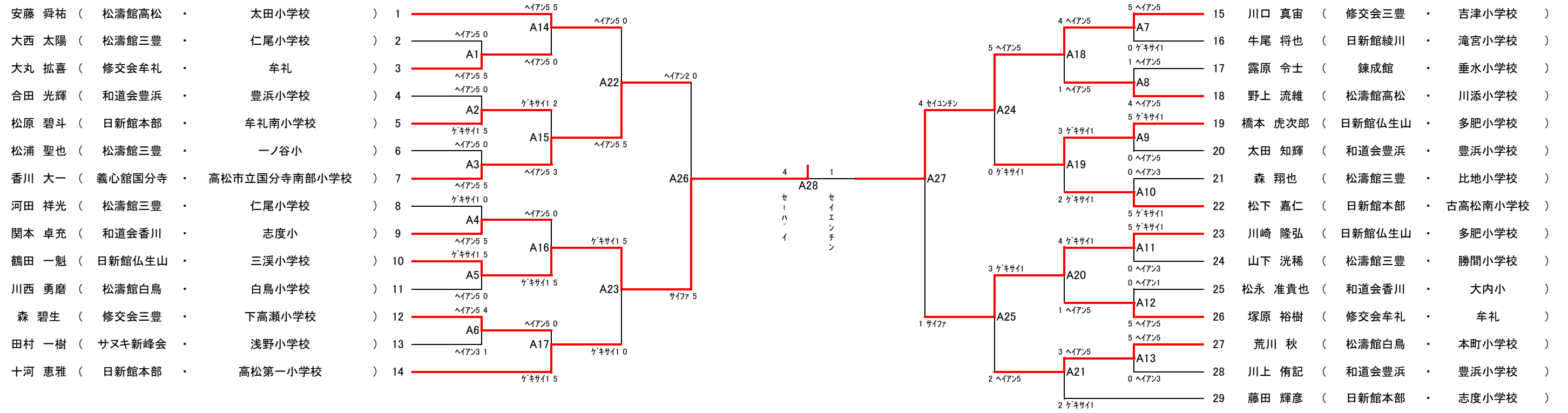

形競技 小学5年女子

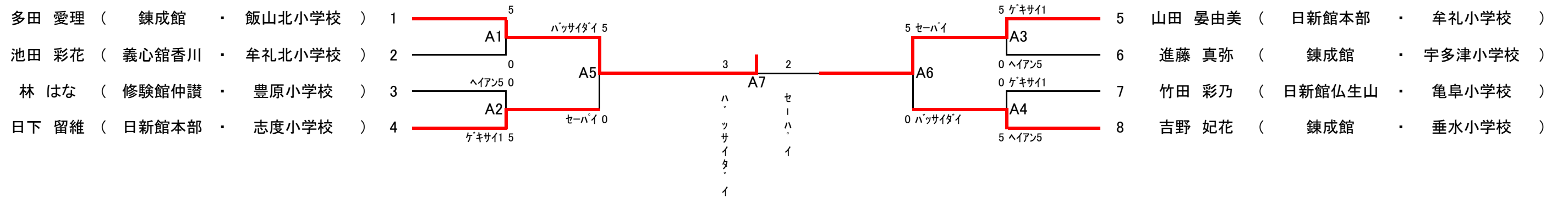

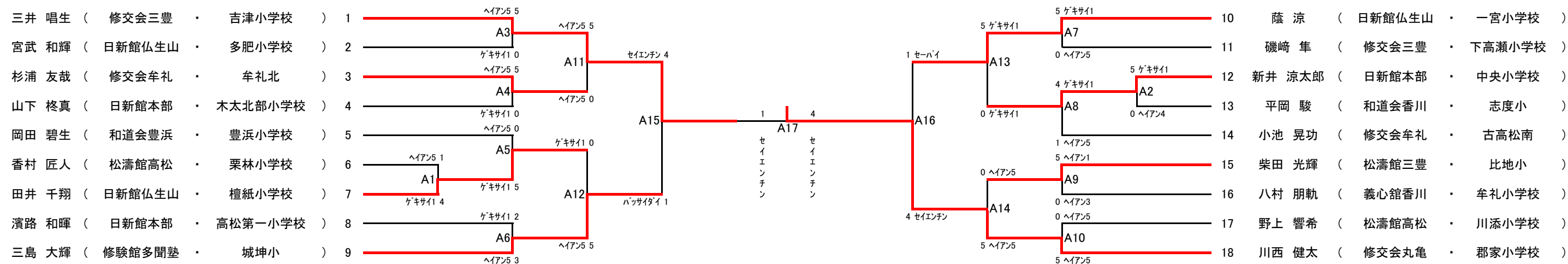

形競技 小学6年女子

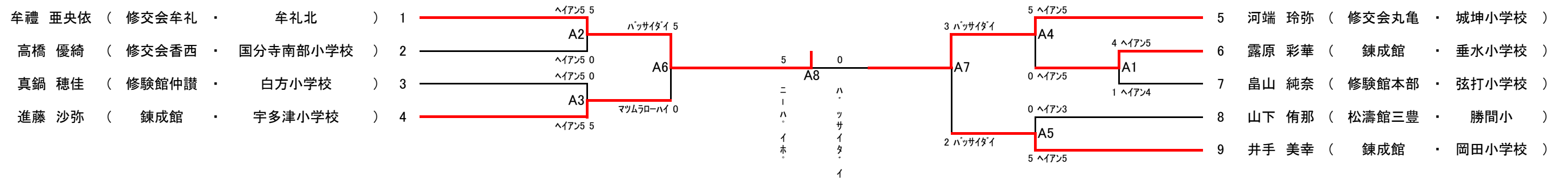

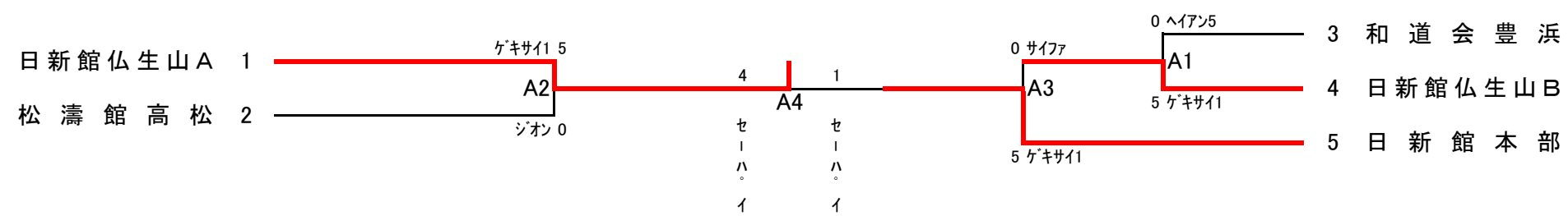

形競技 団体戦 女子

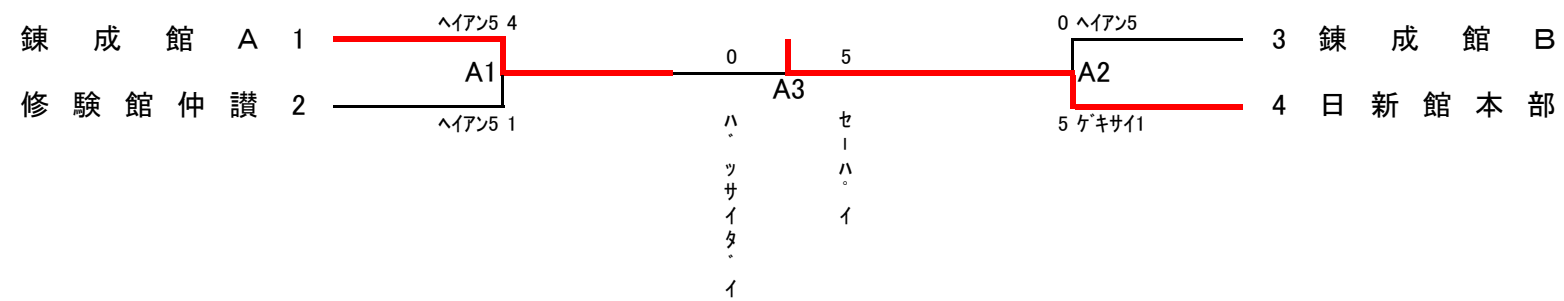

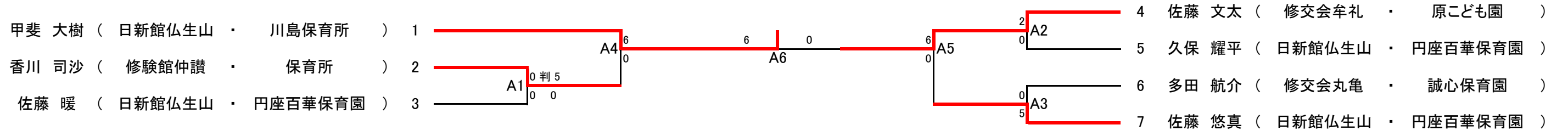

組手競技 幼児女子

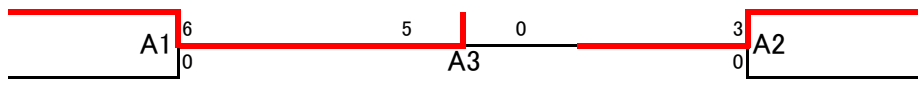
堂尾 苺愛 (日新館仏生山 ・ 鬼無幼稚園)	1		3	植松 凜 (日新館仏生山 ・ 相愛幼稚園)
近藤 花帆 (日新館仏生山 ・ 太田百華幼稚園)	2		4	田邊 希羽 (義心館香川 ・ さぬき市立鶴羽幼稚園)

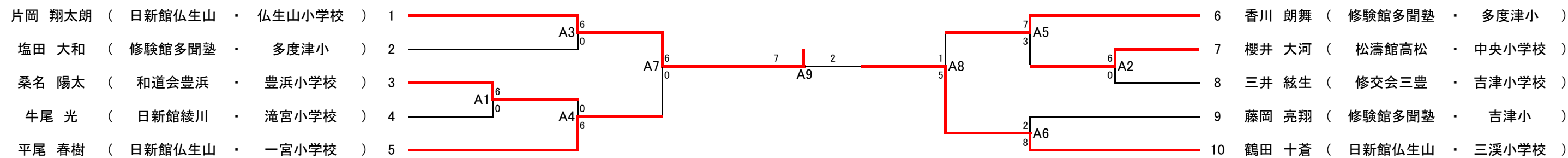

組手競技 小学1年女子

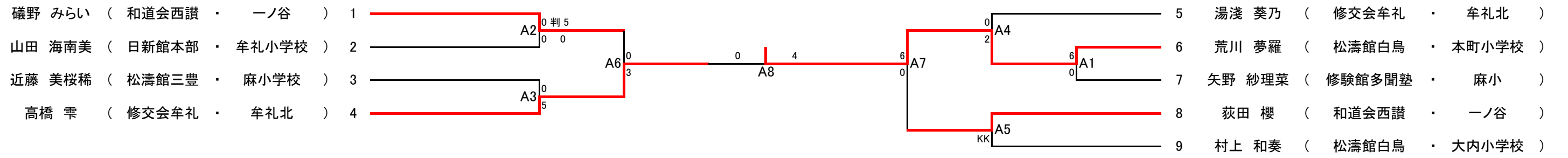

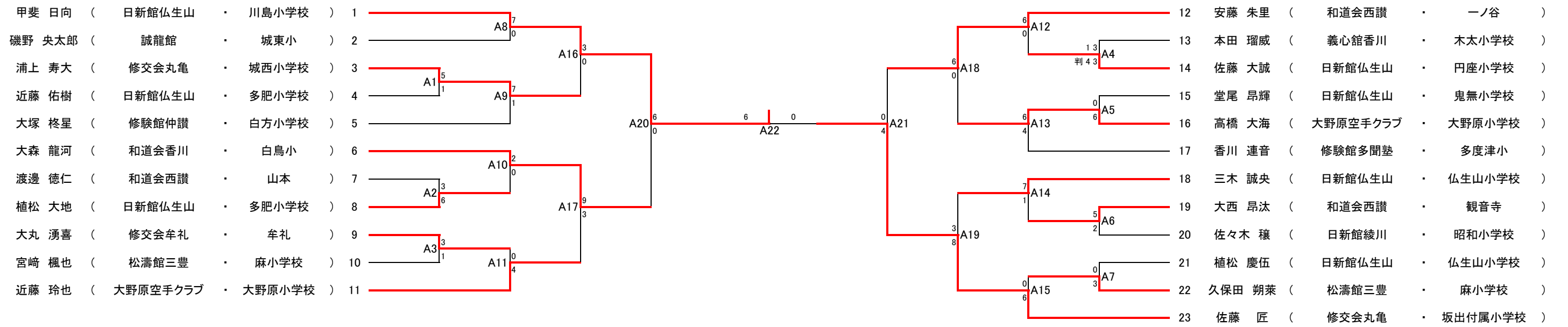

組手競技 小学2年女子

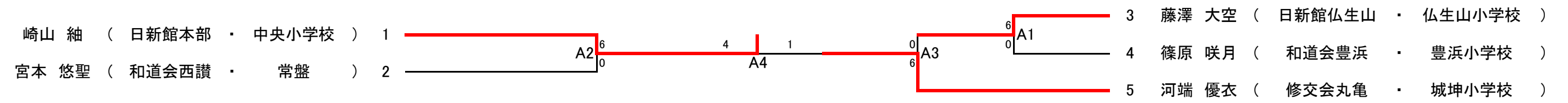

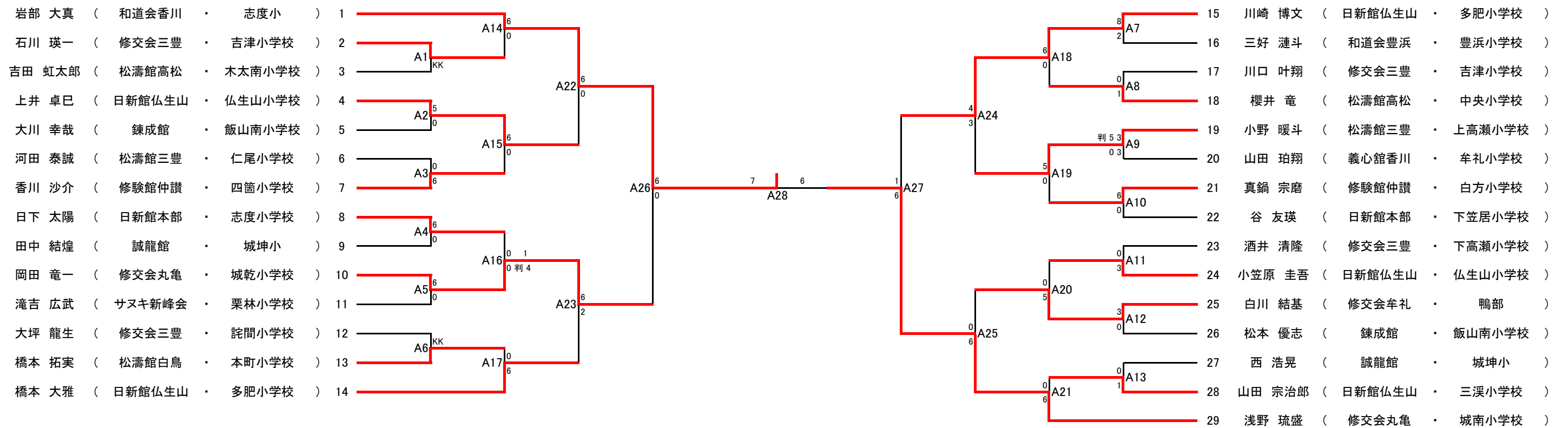

組手競技 小学3年女子

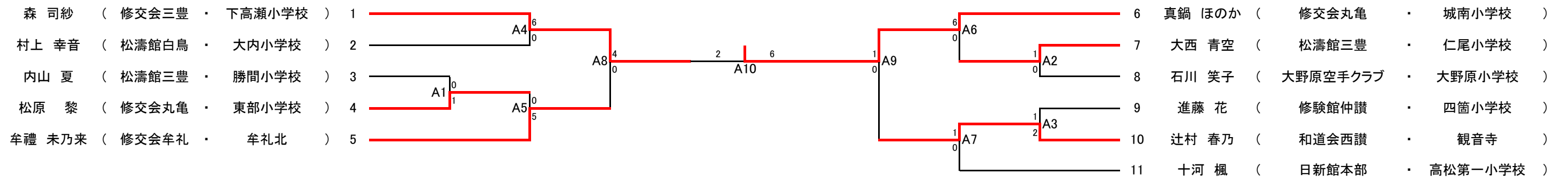

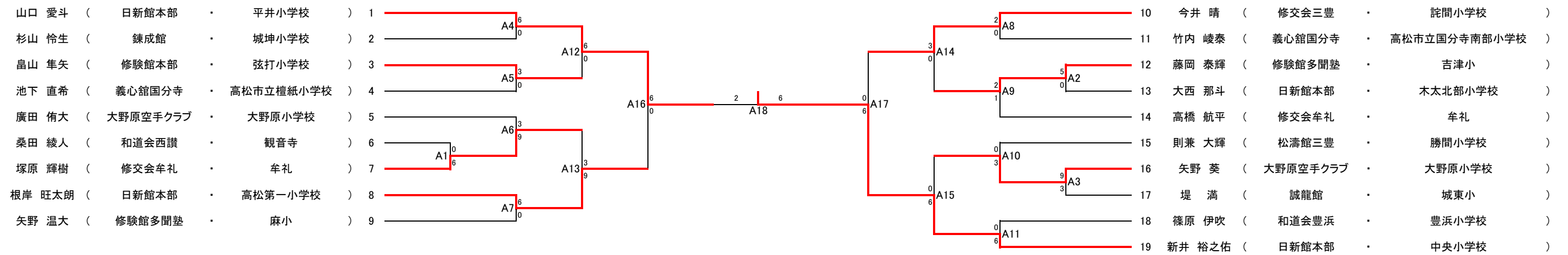

組手競技 小学4年女子

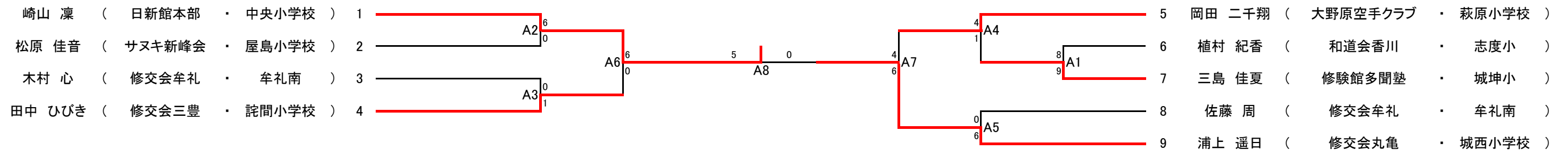

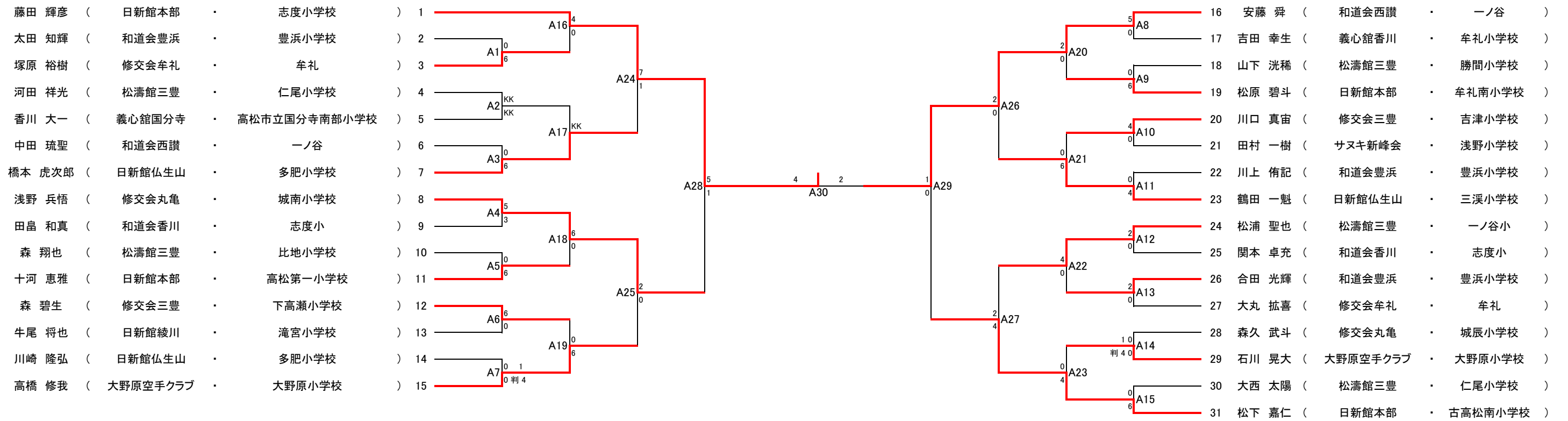

組手競技 小学5年女子

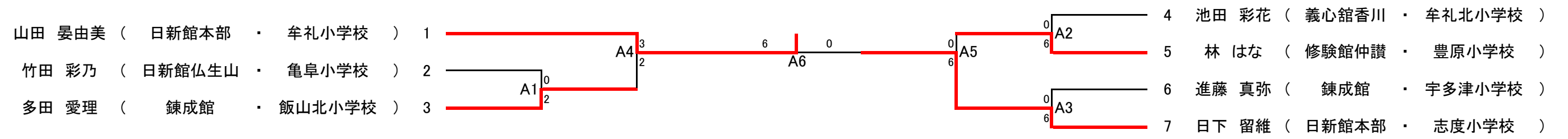

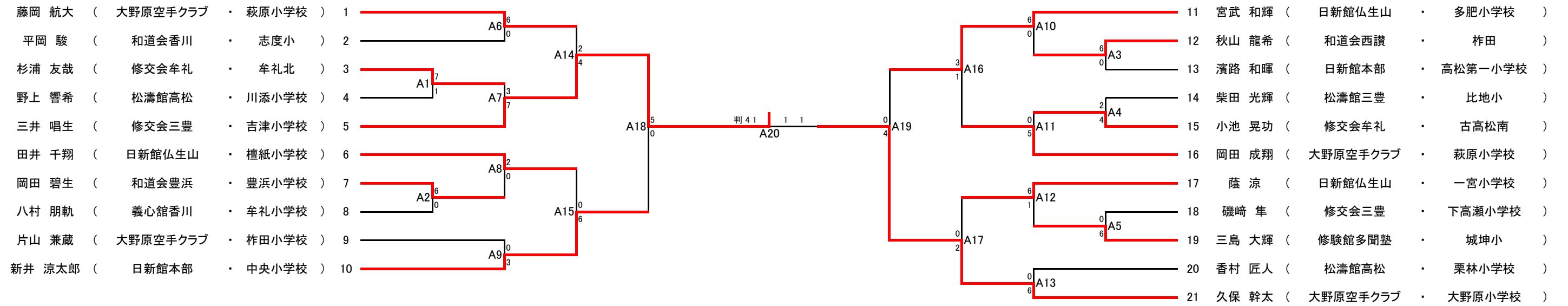

組手競技 小学6年女子

